

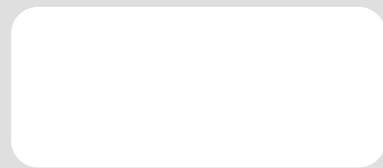

SYSTEM 45T
Sliding

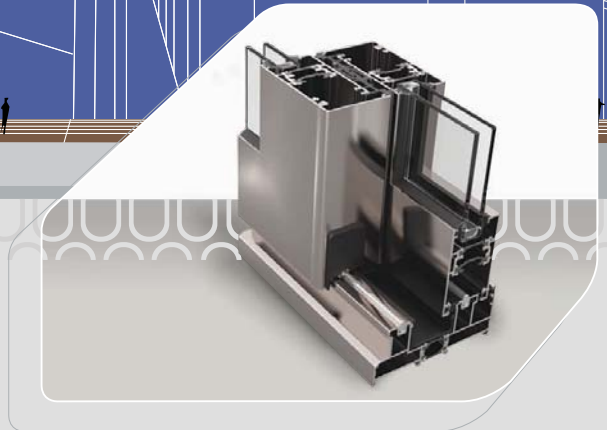

SYSTEM 45T Sliding



System Properties:

- 1- Sliding
- 2- Lift & Slide

Modern Design

- Thickness : 1.5 mm
- Vent Height : 45 mm
- Isolatin Bar : 32 mm
- EPDM Gaskets
- For Sliding - Brush
- For Lift & Slide - TPV Gasket
- Glass Thickness: 20 mm - 34 mm

Sliding

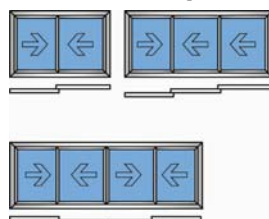

Lift & Slide

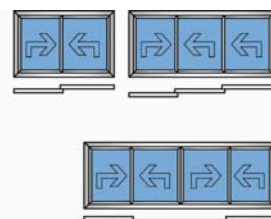

Code Explanation:

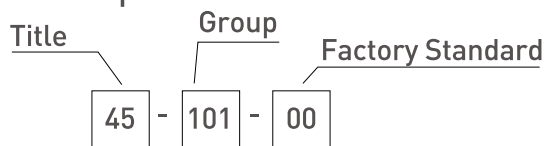

Titles:

- 45 - System Name
- 09 - Extruded Corner Joints



Groups:

- 101, 102, ... - Frame
- 201, 202, ... - Vent
- 301, 302, ... - Mullions
- 501, 502, ... - Adaptors
- 801, 802, ... - Glazing Beats

Alloy:

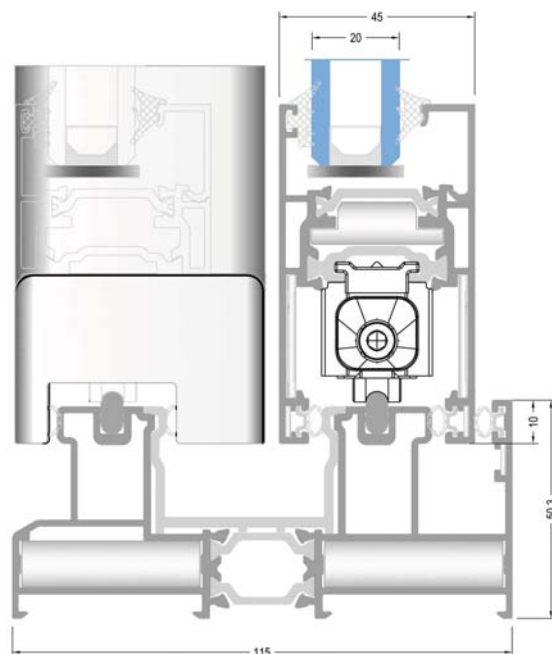
The alloys of the aluminium profiles are 6060 and 6063 (AlMgSi 0,5 - F22) based on EN 12020-2/755-9 standards .



Sliding		EM45-02	Brush
Lift & Slide		EM45-03	TPV Gasket

PROFILES

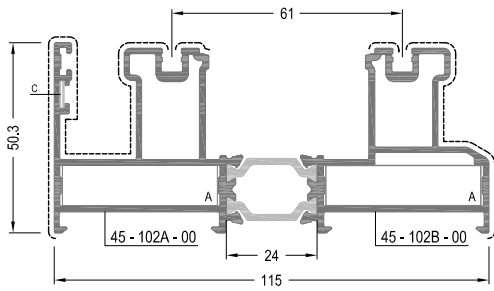

CODE	THEORETICAL WEIGHT kg/m
45 - 102 - 00	2.318
EXTRUDED CORNER JOINT	
A CC - 101 - 41	LC - 1141
DIE - CAST CORNER JOINT	
C LC - 107	

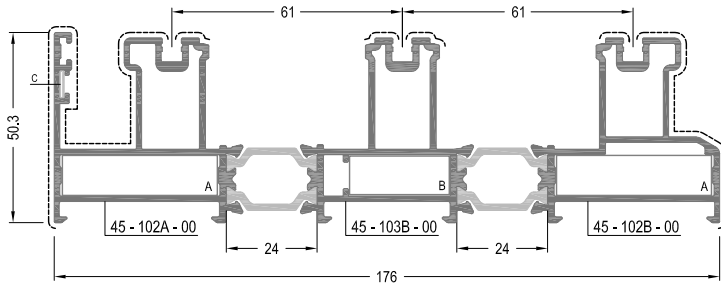

CODE	THEORETICAL WEIGHT kg/m
45 - 103 - 00	3.505
EXTRUDED CORNER JOINT	
A CC - 101 - 41	LC - 1141
DIE - CAST CORNER JOINT	
B CC - 101 - 26.7	LC - 1127
C LC - 107	

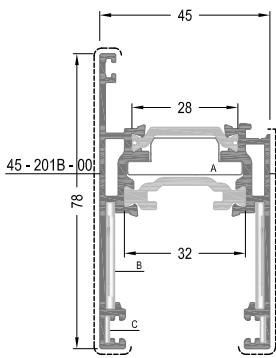

CODE	THEORETICAL WEIGHT kg/m
45 - 201 - 00	1.427
CORNER JOINT	
A 02923000	
B 02921000	
C LC - 107	

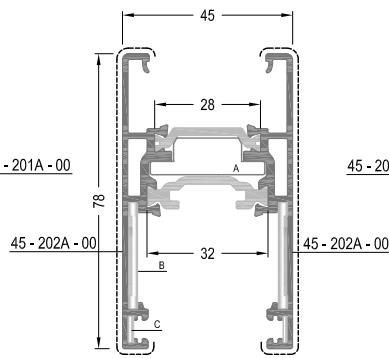

CODE	THEORETICAL WEIGHT kg/m
45 - 202 - 00	1.545
CORNER JOINT	
A 02923000	
B 02921000	
C LC - 107	

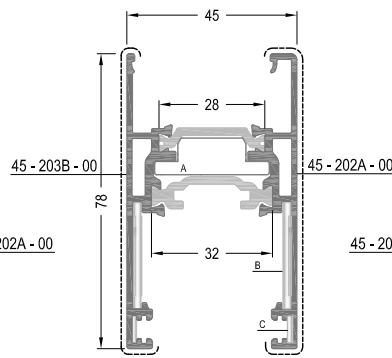

CODE	THEORETICAL WEIGHT kg/m
45 - 203 - 00	1.516
CORNER JOINT	
A 02923000	
B 02921000	
C LC - 107	

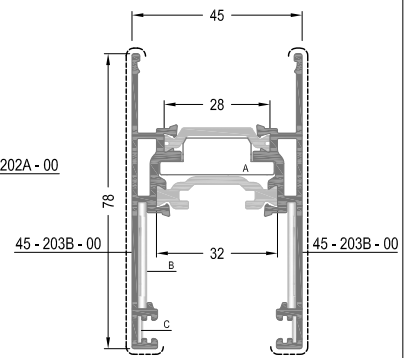

CODE	THEORETICAL WEIGHT kg/m
45 - 204 - 00	1.427
CORNER JOINT	
A 02923000	
B 02921000	
C LC - 107	

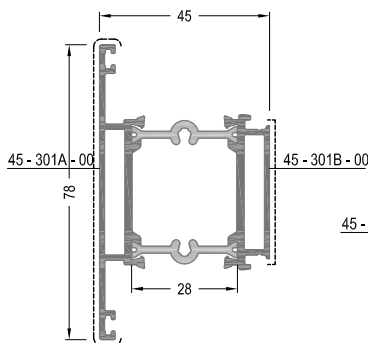

CODE	THEORETICAL WEIGHT kg/m
45 - 301 - 00	1.310

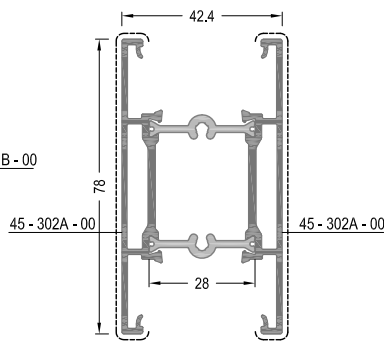

CODE	THEORETICAL WEIGHT kg/m
45 - 302 - 00	1.496

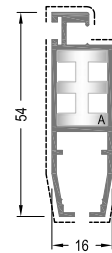

CODE	THEORETICAL WEIGHT kg/m
1621	0.499
DIE - CAST CORNER JOINT	
A MS 13	

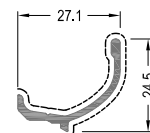

CODE	THEORETICAL WEIGHT kg/m
45 - 501 - 00	0.219
ADAPTER CUP	
A EM45 - 501	

PROFILES

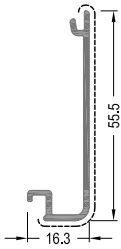

CODE
45 - 502 - 00

THEORETICAL WEIGHT kg/m
0.328

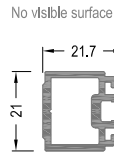

CODE
45 - 503 - 00

THEORETICAL WEIGHT kg/m
0.428

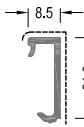

CODE
45 - 802 - 00

THEORETICAL WEIGHT kg/m
0.145

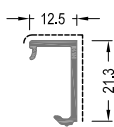

CODE
45 - 803 - 00

THEORETICAL WEIGHT kg/m
0.161

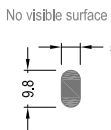

CODE
13 - 134 - 050R

THEORETICAL WEIGHT kg/m
0.118

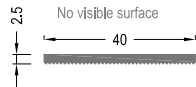

CODE
45 - 508 - 00

THEORETICAL WEIGHT kg/m
0.244

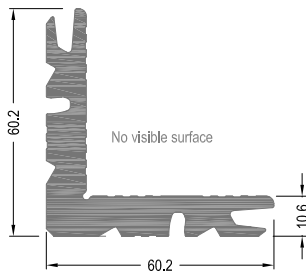

CODE
09 - 101 - 00

THEORETICAL WEIGHT kg/m
2.570

Maximum Capacity Weights Tables

80 kg

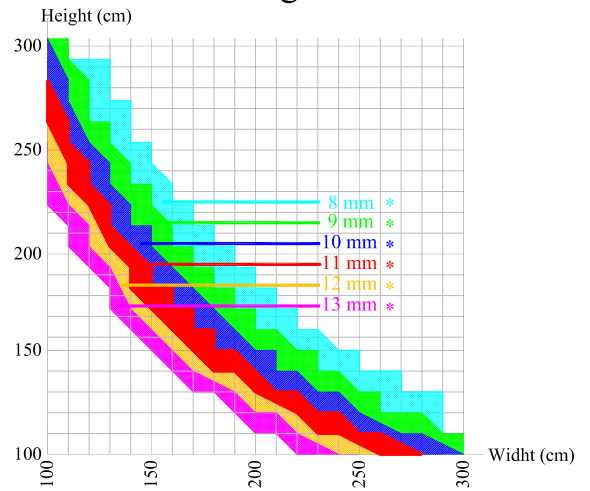

160 kg

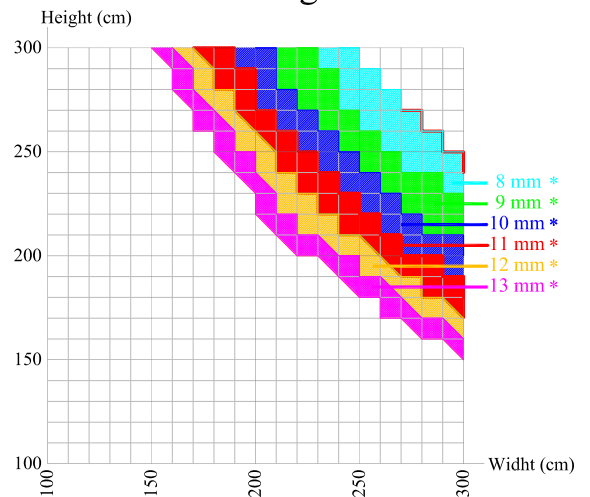

200 kg

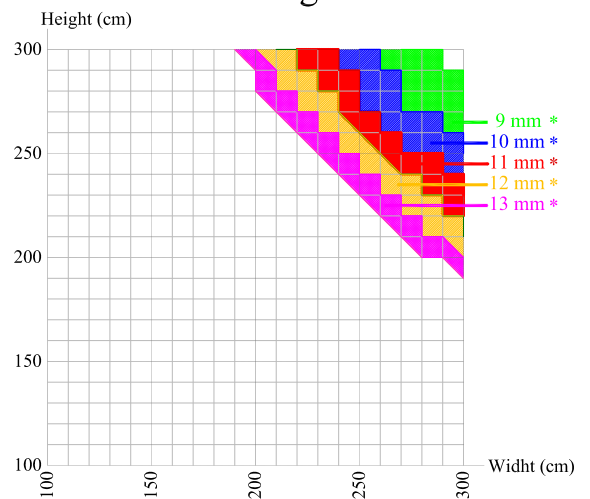

* These Dimensions Are Only Glass Thickness (Without Air Space)

ACCESSORIES

CODE	DRAWING	APPLICATION	DESCRIPTION	THEORETICAL WEIGHT kg/m	IN ONE PACKAGE
EM1 - 02			Glazing Gasket Inside (EPDM)	0.050	300 m
EM1 - 03			Glazing Gasket Inside (EPDM)	0.060	250 m
EM1 - 04			Glazing Gasket Inside (EPDM)	0.070	215 m
EM2 - 01			Glazing Gasket Outside (EPDM)	0.080	185 m
EM45 - 02			Brush	0.025	225 m
EM45 - 03			TPV Gasket	0.018	300 m
EM45 - 05			F & S Frame Gasket	0.076	500 m

WITHOUT GLAZING BEAT

GLAZING THICKNESS	GLAZING GASKET INSIDE	GLAZING GASKET OUTSIDE	VENT PROFILE CODE
20 mm	EM1 - 04	EM1 - 04	45 - 202 - 00
22 mm	EM1 - 03	EM1 - 03	45 - 202 - 00
24 mm	EM1 - 02	EM1 - 02	45 - 202 - 00
26 mm	EM1 - 03	EM1 - 04	45 - 203 - 00
28 mm	EM1 - 02	EM1 - 03	45 - 203 - 00
30 mm	EM1 - 04	EM1 - 04	45 - 204 - 00
32 mm	EM1 - 03	EM1 - 03	45 - 204 - 00
34 mm	EM1 - 02	EM1 - 02	45 - 204 - 00

WITH GLAZING BEAT

GLAZING THICKNESS	GLAZING GASKET INSIDE	GLAZING GASKET OUTSIDE	GLAZING BEAD
20 mm	EM1 - 04	EM2 - 01	45 - 803 - 00
22 mm	EM1 - 02	EM2 - 01	45 - 803 - 00
24 mm	EM1 - 04	EM2 - 01	45 - 802 - 00
26 mm	EM1 - 02	EM2 - 01	45 - 802 - 00











PROFILE CODE	DRAWING	PACKAGE CODE	QUANTITY	CUTTING SIZE	APPLICATION PROFILES	APPLICATION DETAIL
09 - 101 - 00		CC - 101 - 41	- pieces	- mm	45 - 102 - 00 45 - 103 - 00	
09 - 101 - 00		CC - 101 - 26.7	- pieces	- mm	45 - 103 - 00	

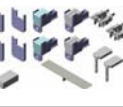

CODE	DRAWING	APPLICATION PROFILES	APPLICATION DETAIL
LC - 1141		45 - 102 - 00 45 - 103 - 00	
LC - 1127		45 - 103 - 00	
LC - 107		45 - 102 - 00 45 - 103 - 00 45 - 201 - 00 45 - 202 - 00 45 - 203 - 00 45 - 204 - 00	
02923000		45 - 201 - 00 45 - 202 - 00 45 - 203 - 00 45 - 204 - 00	
02921000		45 - 201 - 00 45 - 202 - 00 45 - 203 - 00 45 - 204 - 00	
MS 13		1621	

ACCESSORY CODE	DRAWING	PROFILES	APPLICATION DETAIL
EM45-11		PVC	
EM45-12		Polyamid	
EM45-14		PVC Profile	

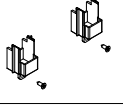
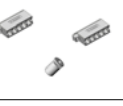
ACCESSORY CODE	DRAWING	DESCRIPTION	APPLICATION DETAIL
EM15 - 200		ROD PROFILE	

ACCESSORIES

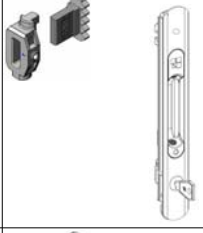
CODE	DESCRIPTION	PICTURE	Slide		Lift & Slide	
			80 kg	160 kg	80 kg	200 kg
02910000	Pulley With Wheel		X			
02911000	Pulley With 2 Wheels			X		
02912000	Kit Pulleys L & S 1 Wheel + Mechanism				X	
02913000	Kit Pulleys L & S 2 Wheels + Mechanism					X
02931000	Locking Kit		X	X	X	X
02935000	Central Plugs Kit For Sliding		X	X		
02943000	Central Plugs Kit For L&S				X	X
02933000	Shock Absorber And Lift_Proof Plugs Kit For Sliding		X	X		
02939000	Shock Absorber And Lift_Proof Plugs Kit For L & S				X	X
02947000	Cap For 4 Sash		X	X	X	X
02954000	Fixed Sash Kit		X	X	X	X
MS 20	Pulley		X	X	X	X

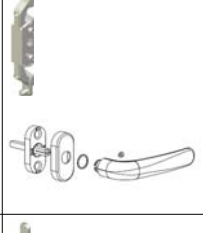
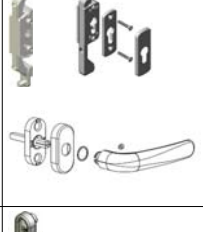
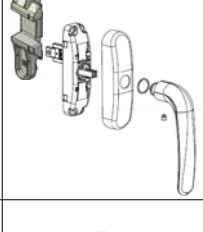
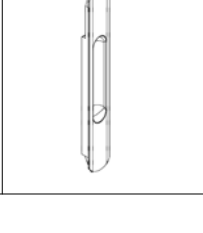
CODE	DESCRIPTION	PICTURE	Slide		Lift & Slide	
			80 kg	160 kg	80 kg	200 kg
EM45 - 91	Embedding Handle		X	X		
EM45 - 92	Embedding Handle With Lock		X	X		
EM45 - 93	Embedding Lever Handle					X
EM45 - 94	Handle		X	X	X	X
EM45 - 95	Handle With Lock		X	X	X	X
EM45 - 96	Cremone		X	X		
02980000	Pulling Handle		X	X		

DETAILS

